

Article number: 20990ALD16500EL

Description: E+G GN 990 Construction tube round
GN 990-AL-D16-500-EL

Measures

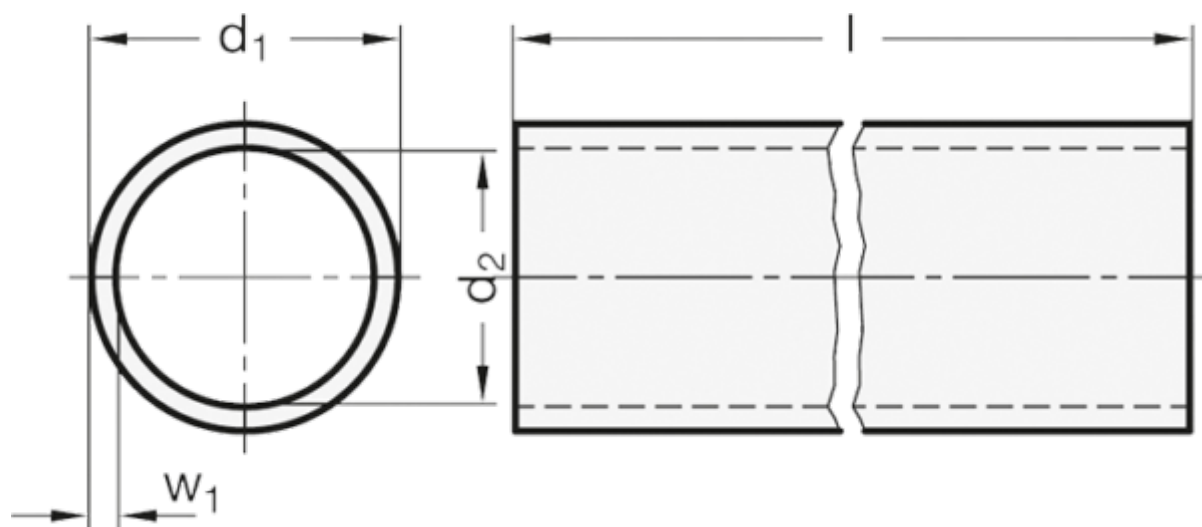

d_1 = D16 +0.05/-0.15

d_2 = 13

$l \pm 0.5$ = 500

w_1 = 1.5

Weight in (g) = 92